









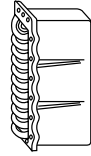
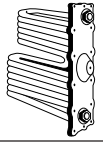
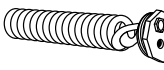
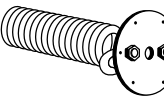
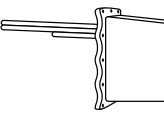
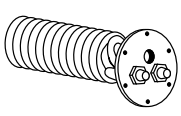
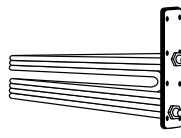
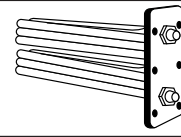
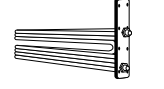
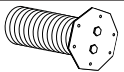

PHONE/FAX: 617-924-3877 • FAX: 617-924-7271 • TOLL FREE PHONE: 1-800-654-8045

E-MAIL / WEB SITE: sales@t*fi*-everhot.com • WEB SITE: www.t*fi*-everhot.com

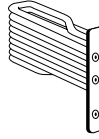
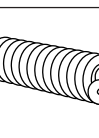
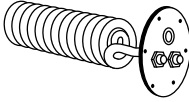

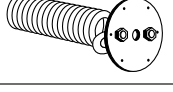
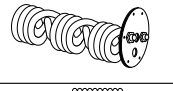
FACTORY: Therma-Flow, Inc. • 191 Arlington Street • Watertown, MA 02472 • MAIL: P.O. Box 416 • Watertown, MA 02471-0416

## TruFin Tube Tankless Heaters

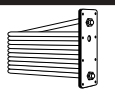
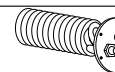
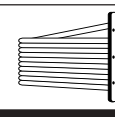
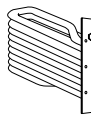
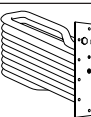

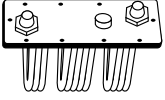
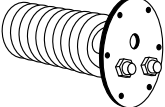
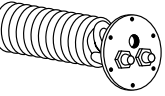
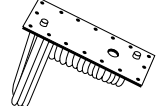
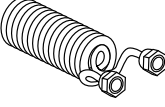
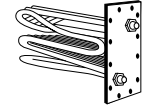
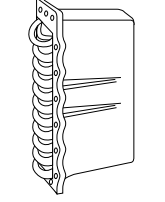
BOILER SERIES	HEATER NUMBER	CAP. GPM	CATEGORY
<b>AMERICAN</b>			
 <p><b>OAKMONT 8—11</b> 8" x 19½" - 17 BH</p>	585-6	6	<b>A</b>
	585-8	8	
	585-10	10	
	585-12	12	
	585-15	15	
 <p><b>ARCOLINER WIDE BACK</b> 6½" x 17¾" - 14 BH</p>	589-5	5	<b>B</b>
	589-6	6	
	589-8	8	
	589-10	10	
 <p><b>ARCOLINER N.B.</b> 4" IPS SCREW TYPE</p>	603-4	4	<b>C</b>
	604-5	5	
	605-6	6	
 <p><b>ARCOLEADER</b> 8" DIA. - 6 BH</p>	732-5	5	<b>D</b>
	743-6	6	
	748-8	8	
 <p><b>SEVERN Extended Shell*</b> 7½" x 13½" - 12 BH</p>	590-5	5	<b>E</b>
	590-6	6	
	*590-8	8	
 <p><b>V—3 A—3</b> <b>FRA—3 PFA—3</b> <b>G—2 G—40</b> 7½" DIA. - 6 BH</p>	226	4	<b>C</b>
	232	5	
	236	6	
	248	8	
	4010	10	
 <p><b>A—5 FRA—5</b> Water Only* 4¼" x 14½" - 8 BH</p>	534-4	4	<b>B</b>
	535-5	5	
	536-6	6	
	*538-8	8	
 <p><b>PFA—5</b> 5¾" x 11" - 6 BH</p>	505-5	5	<b>F</b>
	506-6	6	
	508-8	8	
	510-10	10	
 <p><b>G—10</b> Water Only* 5½" x 12" - 8 BH</p>	1023-5	5	<b>F</b>
	1023-6	6	
	*1023-8	8	
<b>AXEMAN ANDERSON</b>			
 <p><b>Axe Anderson/AA</b> 6" x 7" - 6 BH</p>	AA-5	5	<b>G</b>
 <p><b>PVT</b> 8⅛" x 8⅛" - 8 BH</p>	PVT-5	5	<b>G</b>

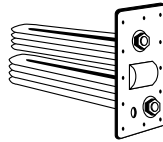
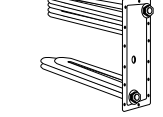
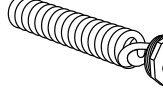
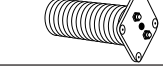
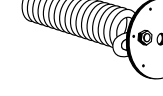
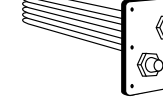
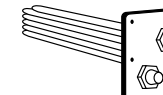
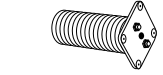

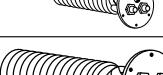
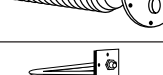
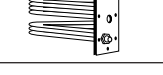
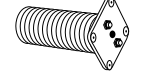
BOILER SERIES	HEATER NUMBER	CAP. GPM	CATEGORY	
<b>BURNHAM</b>				
 <p><b>YELLOW JACKET</b> 7" x 9¾" - 10 BH</p>	YJ1-5	5	<b>G</b>	
	YJ1-6	6		
	YJ1-8	8		
 <p><b>FIESTA</b> 8½" x 12½" - 10 BH</p>	FT-5	5	<b>G</b>	
	FT-6	6		
	FT-8	8		
 <p><b>JUBILEE 100</b> HOLIDAY 60-61-62 PM-PB-PP HOLIDAY 6-72 GAS Water Boilers 7½" DIA. - 6 BH</p>	101-5	5	<b>C</b>	
	101-6	6		
	101-8	8		
	101-10	10		
 <p><b>PACEMAKER</b> HOL. 60-61—Steam 7½" DIA. - 6 BH</p>	201-4	4	<b>G</b>	
	201-5	5		
	201-6	6		
 <p><b>JUBILEE 200-FR</b> Water Boilers 8" DIA. - 6 BH</p>	BTW-5	5	<b>D</b>	
	BTW-6	6		
	BTW-8	8		
	BTW-10	10		
 <p><b>JUBILEE 200-FR</b> Steam Boilers 8" DIA. - 6 BH</p>	BTS-5	5	<b>G</b>	
	BTS-6	6		
	BTS-8	8		
 <p><b>CB, PENN</b> 6" x 13½" - 10 BH</p>	Penn 10-5	5	<b>G</b>	
	Penn 10-6	6		
 <p><b>RSM</b> 6⅛" x 11⅛" - 12 BH</p>	RSM-5	5	<b>G</b>	
	RSM-6	6		
 <p><b>RSA</b> 7" x 8" - 10 BH</p>	RSA-5	5	<b>G</b>	
<b>BURNHAM</b>				
<b>SAME AS AMERICAN RADIATOR</b>				
 <p><b>V—1</b> <b>V—7</b> <b>V—8</b> <b>V—9</b> 5" x 12¼" - 8 BH</p>	MUST SPECIFY SERIES WHEN ORDERING	V1-5	5	<b>B</b>
	V1-6	6		
	V1-8	8		
 <p><b>V-7 ROUND and V-8</b> 7½" DIA. - 6 BH</p>		V7-5	5	<b>B</b>
		V7-6	6	
		V7-8	8	
 <p><b>V-11</b> 6" x 11¾" - 8 BH</p>		V-11-8	8	<b>B</b>
		V-11-10	10	
		V-11-12	12	
		V-11-15	15	
<b>COLUMBIA</b>				
 <p><b>EMERALD</b> 7" x 12¼" - 8 BH</p>	EM-5	5	<b>G</b>	
 <p><b>GEM</b> 6" x 13½" - 10BH</p>	GEM-5	5	<b>G</b>	

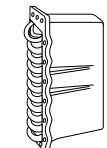
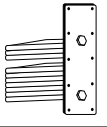
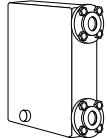
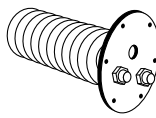
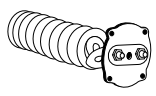
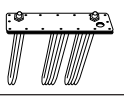
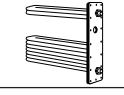
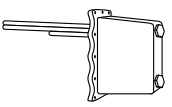
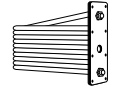
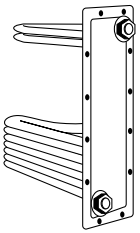
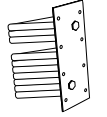

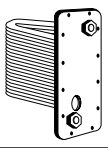
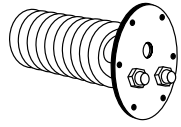
BOILER SERIES	HEATER NUMBER	CAP. GPM	CATEGORY
<b>CROWN</b>			
 <p><b>BON-AIR</b> 6 1/4" x 11 3/4" - 10 BH</p>	ULT - 5	5	<b>F</b>
	ULT - 6	6	
	ULT - 8	8	
	ULT - 10	10	
 <p><b>MONTEGO</b> 8" DIA. - 6 BH</p>	DF - 5	5	<b>D</b>
	DF - 6	6	
	DF - 8	8	
	DF - 10	10	
 <p><b>ENERGY PAK</b> 6 3/8" DIA. - 6 BH</p>	CEP-5	5	<b>D</b>
	CEP-6	6	
	CEP-8	8	
	CEP-10	10	
<b>DELCO—FLAT PLATE TYPE</b>			
 <p>DB 3—4—5 8 3/4" x 20" - 16 BH</p>	DB - 6	6	<b>G</b>
	DB - 8	8	
	DB - 10	10	
<b>DUNKIRK—DELCO—FEDERAL PARAGON—PIETRO (CAST IRON BOILERS)</b>			
 <p>DUNKIRK 13W—15W—S DELCO 525—1260 FED. OXFORD JUPITER (Specify) CONN. CTRS. 2 3/4" — 7"</p>	D - 5	5	<b>C</b>
	D - 6	6	
	D - 8	8	
	150 - 5	5	
<p>DUNKIRK SUPER 13" LEXINGTON &amp; LEX. PAK 8" DIA. - 6 BH</p>	DF-5	5	<b>D</b>
	DF-6	6	
	DF-8	8	
<p>DUNKIRK—DELRAY—DELCO 2D—GAS 13 STEAM G.S.B. 6 1/2" x 17" - 14 BH</p>	GU-5	5	<b>B</b>
	GU-6	6	
	GU-8	8	
<b>HART &amp; CROUSE — BRYANT</b>			
 <p>COMPACT 230-231-234 5 1/4" x 12" - 12 BH</p>	HC - 5	5	<b>E</b>
	HC - 6	6	
	HC - 8	8	
<b>UNITS 16 BOLT HOLES SHELL TYPE FOR CAST IRON BOILERS</b>			
 <p>AMERICAN 12 KOHLER 22 COLUMBIA DELCO — R &amp; B RICHARDSON BRYANT 244-245 NATIONAL OLD STYLE 2-3-018 LB PIERCE-BUTLER 8 1/4" x 20" - 16 BH</p>	919 - 6	6	<b>A</b>
	919 - 8	8	
	919 - 10	10	
	919 - 12	12	
	919 - 15	15	
	919 - 20	20	

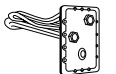
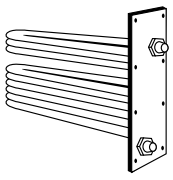
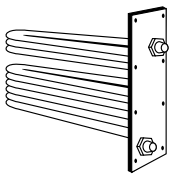
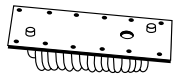
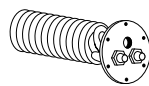
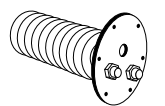
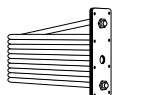
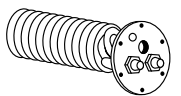
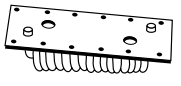
BOILER SERIES	HEATER NUMBER	CAP. GPM	CATEGORY
<b>H.B. SMITH</b>			
 <p>20-25-200-250 201-251 2500 A-L-ABC 2500 A-L 6 1/2" x 12" - 12 BH</p>	SS-6	6	<b>F</b>
	SS-8	8	
	SS-10	10	
	SS-12	12	
	SS-15	15	
 <p>1100-1500 FLANGE TYPE 6 1/2" x 16" - 14 BH</p>	1500-5	5	<b>E</b>
	1500-6	6	
	1500-8	8	
	1500-10	10	
 <p>CENTURY GAS III 100-150-G300 SCREW TYPE 4" IPS</p>	30-4	4	<b>C</b>
	30-5	5	
	30-6	6	
	30-8	8	
 <p>PAC 12-FD SERIES 8 WATER 7 3/4" x 7 3/4" - 4 BH</p>	FD-12-5	5	<b>B</b>
	FD-12-6	6	
	FD-12-8	8	
 <p>OB-14 12" DIA. - 6 BH</p>	OB-14-5	5	<b>F</b>
	OB-14-6	6	
	OB-14-8	8	
	OB-14-10	10	
	OB-14-12	12	
 <p>28-STEAM BOILERS 7 1/2" x 8 1/2" - 6 BH</p>	28-6	6	<b>F</b>
	28-8	8	
	28-10	10	
	28-12	12	
	28-15	15	
 <p>18 SERIES 19 SERIES Specify Series 5 3/4" x 12" - 6 BH</p>	18-6	6	<b>F</b>
	18-8	8	
	18-10	10	
	18-12	12	
	18-15	15	
 <p>SERIES 8 STEAM 7 1/4" x 7 1/4" - 4BH</p>	ST-8-4	4	<b>B</b>
	ST-8-5	5	
<b>HYDROTHERM</b>			
 <p>OS — SOT 4 3/4" x 10" - 8 BH</p>	ST - 5	5	<b>F</b>
	ST - 6	6	
 <p>AQUARIUS 7 1/2" DIA. - 6 BH</p>	AQ - 5	5	<b>F</b>
	AQ - 6	6	
 <p>VO—WT-WATER 6" DIA. - 6 BH</p>	VO - 4	4	<b>B</b>
	VO - 5	5	
	VO - 6	6	
 <p>VOA - STEAM 5 3/4" x 11 1/4" - 10 BH</p>	VOA - 5	5	<b>B</b>
	VOA - 6	6	
	VOA - 8	8	
 <p>PB150-180 (Water) 7 3/4" x 7 3/4" - 4 BH PB150-180 (Steam) 7 1/4" x 7 1/4" - 4 BH</p>	FD12-5	5	<b>B</b>
	ST8-5	5	

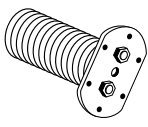
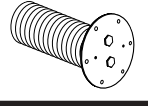
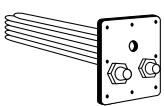
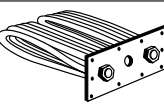
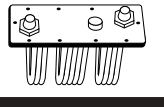
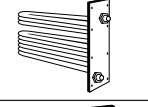
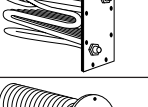
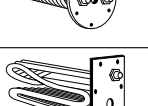
BOILER SERIES	HEATER NUMBER	CAP. GPM	CATEGORY							
<b>NATIONAL-U.S.-CRANE-THATCHER</b>										
	NAT.-U.S. 2-9-16-16C-20 25-28-32 THATCHER 0271-0754 8 3/4" x 20" - 16 BH	919 - 6 919 - 8 919-10 919-12 919-15 919-20	6 8 10 12 15 20	A						
		NAT.-U.S. SUNRAY IV-19 CRANE-5 THATCHER-OC 6 1/2" x 17 1/2" - 10 BH	T194-4 T195-5 T196-6 T198-8 T910-10		4 5 6 8 10	B				
			NAT.-U.S. 10-15-27-37-47 CRANE-21-31-41 (External Type) 13 1/4" x 19 1/2" x 5 1/2"		NR-6 NR-8 NR-10 NR-12 NR-15 NR-20		6 8 10 12 15 20	A		
					NAT.-U.S. 17-18 70-101-109-209 300 CRANE 2-8-11-12 202-300-302 THATCHER-G-OP 7 1/4" DIA. - 6 BH		T104 T105 T106 T108 T110 T112 T115		4 5 6 8 10 12 15	C
							CRANE 15-26 6" DIA. - 4 BH		T-15-4 T-15-5 T-15-6 T-15-8	
	NAT.-U.S. 12-12W Flange Type 7" x 22 1/2" - 16 BH			12-5 12-6 12-8		5 6 8	E			
		NAT.-U.S. SUNRAY1-3-46 6 1/2" x 16 1/4" - 13 BH		119-5 119-6 119-8		5 6 8		E		
				CRANE 14-16-20 (Specify Series)		14-5 14-6			5 6	
Extended Shell* 7 1/2" x 13 1/2" - 12 BH			*14 - 8 *14 - 10	8 10	A					
	73 70SS-SW 5" x 12 1/2" - 8 BH	73-5 73-6 73-8	5 6 8	B						
	<b>THATCHER (specify series)</b>									
		015 Through 020 6" x 20 1/4" - 12 BH 56 SERIES 7 3/4" x 19" - 14 BH 525 SERIES 6 1/4" x 14 1/4" - 12 BH	TH-5 TH-6 TH-8		5 6 8	E				
GOLDEN OILMASTER		Water Boilers	Same as Burnham BTW	B						
		Steam Boilers	Same as Burnham BTS							
T.F. GAS		Same as Burnham Holiday 70-80								
<b>NEW YORKER</b>										
	AP, S-AP, FR, WH 7" x 8" - 8 & 10 BH	NY-5 NY-6	5 6	G						
	NY 4 x 9 1/2 4" x 9 1/2" - 8 BH	NY 4 x 9 1/2	4		G					

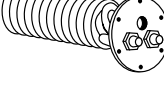
BOILER SERIES	HEATER NUMBER	CAP. GPM	CATEGORY					
<b>PEERLESS</b>								
	JO—JOT 2—2T (Specify) 6 1/4" x 14 1/4" - 12 BH	PE-5 PE-6 PE-8 PE-10	5 6 8 10	B				
		JO—JOT—EC 2-2T 7-7PF 60-61-81 WB LC / LCE 8" DIA. - 6 BH	PF-4 PF-5 PF-6 PF-8 PF-10 PF-12 PF-15 PF-20		4 5 6 8 10 12 15 20	D		
		WBV- STEAM 5 1/8" x 10" - 8 BH	WBV-5 WBV-6	5 6	B			
			ECT—STEAM 5 1/8" x 10" - 8 BH	ECT-5 ECT-6 ECT-8			5 6 8	B
			HEO 7 1/2" x 11" - 8 BH	HEO-5 HEO-6 HEO-8	5 6 8		B	
			<b>RICHMOND — RHEEM — RUUD</b>					
			RHEEM G—O—PO RICHMOND—RWA H-WFD-R-RW-PR (Specify Oil — Gas) 5 1/4" x 13 1/2" - 8 BH	RG - 5 RG - 6 RG - 8	5 6 8			B
			5 1/2" x 15 1/2" - 10 BH	RO - 5 RO - 6 RO - 8	5 6 8		B	
	<b>SLANT FIN</b>							
		GALAXY MALIBU 8 3/4" x 15 3/4" - 12 BH	SF - 5 SF - 6 SF - 8 SF - 10	5 6 8 10	B			
		VANTAGE II FUTURA 7 1/2" DIA. - 6 BH	FUT - 4 FUT - 5	4 5				
			310 7 1/4" DIA. - 6 BH	T104 T105 T106 T108 T110 T112 T115		4 5 6 8 10 12 15	C	
	78 5" x 12 1/2" - 8 BH		73 - 5 73 - 6 73 - 8	5 6 8	B			
			LIBERTY WATER 7 1/2" DIA. - 6 BH	LW - 4 LW - 5 LW - 6 LW - 8 LW - 10		4 5 6 8 10		B
				LIBERTY STEAM 8 1/8" x 15 5/16" - 12 BH		LS - 5 LS - 6 LS - 8 LS - 10		

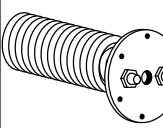
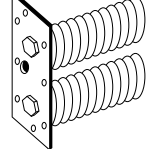
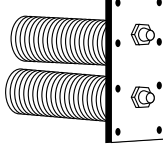
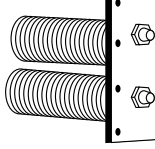
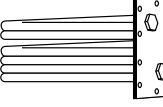
BOILER SERIES	HEATER NUMBER	CAP. GPM	CATEGORY
<b>THERMO-DYNAMICS</b>			
 <p>VTF 7 1/2" RD - 6 BH</p>	V&E - 5 (Flat Sides)	5	G
	V&E - 6 (Flat Sides)	6	
 <p>VTF, CWL, S 8" RD - 6 BH</p>	55- 5	5	G
	55- 6	6	
<b>TRIANCO</b>			
 <p>DBC NEWPORT HORIZON 7 1/2" x 7 1/2" - 8 BH</p>	TR - 4	4	D
	TR - 5	5	
 <p>TOC 5" x 13" - 8 BH</p>	TOC - 5	5	D
	TOC - 6	6	
	TOC - 8	8	
<b>ULTIMATE</b>			
 <p>6 1/4" x 11 3/4" - 10 BH</p>	ULT - 5	5	F
	ULT - 6	6	
	ULT - 8	8	
<b>UTICA</b>			
 <p>STARFIRE ACE—OU 5 1/4" x 13 1/2" - 8 BH</p>	U-5	5	B
	U-6	6	
	U-8	8	
 <p>B—C OIL-GAS 6 1/2" x 10 1/2" - 8 BH</p>	POBT-5	5	B
	POBT-6	6	
	POBT-8	8	
 <p>STARFIRE II &amp; III WATER 7" DIA. - 6 BH</p>	STW-5	5	B
	STW-6	6	
 <p>STARFIRE II &amp; III STEAM 6 1/2" x 10 1/2" - 8 BH</p>	STS-5	5	B
	STS-6	6	
<b>VAILLANT</b>			
 <p>7 1/2" DIA. - 6BH</p>	VA - 4	4	D
	VA - 5	5	
	VA - 6	6	

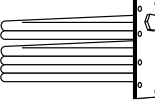
BOILER SERIES	HEATER NUMBER	CAP. GPM	CATEGORY
<b>WEIL-MCLAIN</b>			
 <p>65-66-68—EG 42-62 WATER BOILERS (Specify Series) 7" DIA. - 6 BH</p>	WE-624	4	C
	WE-625	5	
	WE-626	6	
	WE-628	8	
<p>GOLD SERIES 7 3/4" DIA. - 6 BH</p>	G0-5	5	C
	G0-6	6	
	G0-8	8	
 <p>65-66-68—EG—GOLD STEAM BOILERS 6" x 10" - 8 BH</p>	65-S-5	5	B
	65-S-6	6	
	65-S-8	8	
<p>76-86-88 (Specify) STEAM BOILERS 6" x 10" - 8 BH 78 SERIES and 80 SERIES 5 1/4" x 10" - 8 BH</p>	Series 76-78 avail. up to 15 gallons	B	B
	Series 86-88 avail. up to 20 gallons		
<b>WEIL-MCLAIN MULTIPLE HEATERS CAN BE USED WITH 76 OR 86 STEAM BOILERS</b>			
 <p>L.G. STEAM 4" x 11 1/2" - 8 BH</p>	E30-5	5	F
	E30-6	6	
	E30-8	8	
<p>E-62 STEAM BOILERS E - 5 3/4" x 10 3/4" - 8 BH 62 - 5 1/4" x 8 3/4" - 6 BH</p>	62 S-5	5	B
	62 S-6	6	
	62 S-8	8	
 <p>57—77 78—85 8 3/4" x 20" - 16 BH</p>	919-6	6	A
	919-8	8	
	919-10	10	
	919-12	12	
	919-15	15	
	919-20	20	
<p>72—73</p>	72-6	6	B
	72-8	8	
	72-10	10	
	72-12	12	
	72-15	15	
 <p>6 1/4" x 10 1/4" - 10 BH</p>	82—84	82-6	B
	82-8	8	
	82-10	10	
	82-12	12	
	82-15	15	
<p>6" x 14" - 10 BH</p>	OB—15	OB-15-5	B
	5 1/4" x 11 3/4" - 8 BH	OB-15-6	
<p>OB—18 5 1/4" x 13 1/2" - 8 BH</p>	OB-18-5	5	B
	OB-18-6	6	
 <p>92—94—K 5 3/4" x 7" - 6 BH</p>	WM9210	10	B
	WM9215	15	
	WM9220	20	
<b>WILLIAMS—WINKLER STEWART WARNER</b>			
 <p>OILOMATIC—C 6 1/4" x 14 1/4" - 12 BH</p>	PE-OS-5	5	B
	PE-OS-6	6	
	PE-OS-8	8	
	PE-OS-10	10	
<p>6 1/4" x 17 1/2" - 14 BH</p>	SW-6	6	B
	SW-8	8	
	SW-10	10	

# STEEL BOILER TANKLESS

PLEASE SPECIFY BOILER MAKE, SERIES AND NUMBER

BOILER					CAP. GPM	CATEGORY
Acme Dual	Delco	Homease	Norse	Smith-Pac 14	5	G
Albee	Della	Hornet	Natco	Spencer	6	
Aldrich	Diesel	Hydrotherm	Patco	Thermodynamics	7	
Atlantic	Edwards	International	Pacific	Timken	8	
Autoheat	Embassy	Iron Fireman	Paragon	Titusville	10	
Bethlehem	Esso	Kewanee	Peerless	Torrid Heat	12	
Berggren	Fitzgibbons	Keystone	Penn.	Transotherm	15	
Bryant	Federal	Koven	Percoflash	U.S. Htg. & Clg.	16	
Burnham C.B.	Fluid Heat	Loesch	Pietro	Utica	18	
Burnham R.S.M.	Gen. Automatic	Loline	Plymouth	V. & E.	20	
Continental	Gilbarco	Marietta	Portmar	Viking	24	
Crown	Gibraltar	Magic Heat	Quiet May	Wayne	25	
Crane	General Electric	Manville	Repc	Winkler	27	
Crotty	General Htg.	Mastercraft	Rheem	York Shipley	30	
Chrysler	Gentleman Jan.	Mont. Ward	Standard	Zambelli	35	
Columbia	Heil	National	Sears Roebuck		40	
Dallas	Homeart	New Yorker	Slant Fin			

**ADDITIONAL NET CHARGE FOR OVERSIZE PLATES ON SOME STEEL BOILERS — PLEASE INQUIRE.**

**WELDING FLANGE — FOR BOILERS WITH NO COIL OPENINGS — CONSULT FACTORY.**

**QUICK SERVICE ON RETUBING OF TANKLESS — PLEASE INQUIRE FOR BOILERS NOT LISTED.**

**ALL PLATE SIZES ARE APPROXIMATE.**

**FEDERAL—SDF— A & B—GFS  
HAMPTON—XL  
(CONTOURED)  
7 1/2" X 7 1/2" - 6 BH**

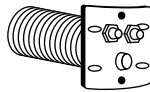

**FEDERAL—FVW—VGF—FTTW  
6" X 17" - 10 BH**

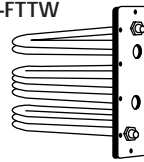

**FEDERAL FC-FD-FLR-FM-FCA-FLR-FM2  
PORTMAR-WINDSOR  
6" X 17" - 10 BH**

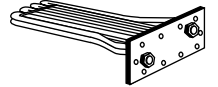

**KOVEN—DELCO—PARAGON—V & E  
5 1/2" X 13 1/2" - 8 BH**

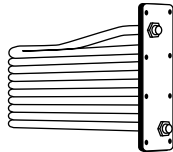

**KOVEN—V & E—PIETRO—O.B.N.  
KOVEN—V & E 6" - 6 BH  
PIETRO—O.B.N. 6 1/4" - 6 BH**

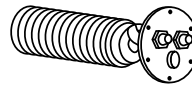

**KOVEN—DELUXE  
8" X 14 1/4" - 14 BH**

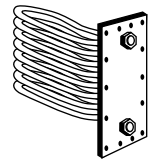

**GIBRALTAR—PARAGON—V & E—REPCO—  
GENERAL HTG PRODUCTS—IRON FIRE  
7" DIA. - 6 BH**

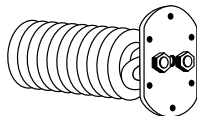

**GIBRALTAR  
5 1/2" X 13 1/2" - 8 BH**

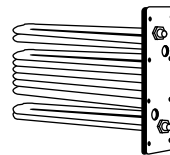

**MANVILLE—MAGIC HEAT  
PACIFIC—SPENCER—COLUMBIA  
1" LOCK NUT CONN.**

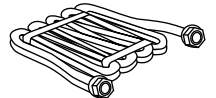

**KEWANEE R—3R—83R  
R—5" X 12 1/2" - 8 BH  
3R—6 1/4" X 15 1/2" - 8 BH  
83R—6 1/4" X 15 1/2" - 12 BH**



**NATIONAL—PACIFIC  
SERIES 200 THRU 700  
5 1/2" X 17 1/4" - 12 BH**

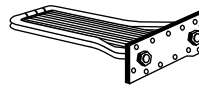

**PORTMAR—NORSE—DELTA  
8" DIA. - 8 BH**

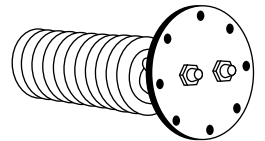

**GENERAL ELECTRIC  
LA 25E THRU 70 E  
1" LOCK NUT CONN.**

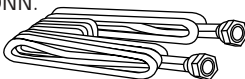

**IRON FIREMAN  
FAIRBANKS MORSE  
UTICA—TORRID HEAT  
6" X 16 1/2" - 16 BH**

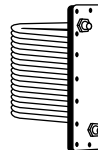

**CROTTY—ZAMBELLI—GENT-JANITOR  
CROTTY—5" X 12 1/2" - 8 BH  
ZAMBELLI—6 1/4" X 13 1/2" - 8 BH  
GENT-JAN.—5" X 12" - 10 BH**

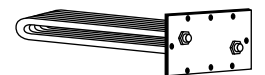

**FITZGIBBONS—400  
CHRYSLER AIRTEMP—PERCOFLASH  
4 3/8" X 13" - 6 BH**

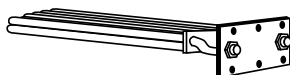

**PERCOFLASH  
FITZGIBBONS—RZU JR.—80-200-4000  
FITZ 6" X 12" - 8 BH  
PERCOFLASH 5 3/4" X 13 1/2" - 8 BH**

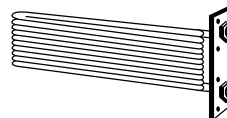

**DIESEL—PLYMOUTH—EDWARDS  
DIESEL-PLYMOUTH— 6" X 16" - 10 BH  
EDWARDS—6" X 12 1/2" - 8 BH**

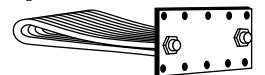

**CAPACITY RATING BASED ON TEMPERATURE RISE FROM 40° TO 140° WITH BOILER WATER 200°  
FIRING RATE TO BE SUITABLE FOR MAINTAINING 200° BOILER WATER — ON ALL UNITS.**